



# Dotser Agri

Machinery & Parts Dealer Platform

## SELL MACHINERY & PARTS

All-In-One Central Software Platform

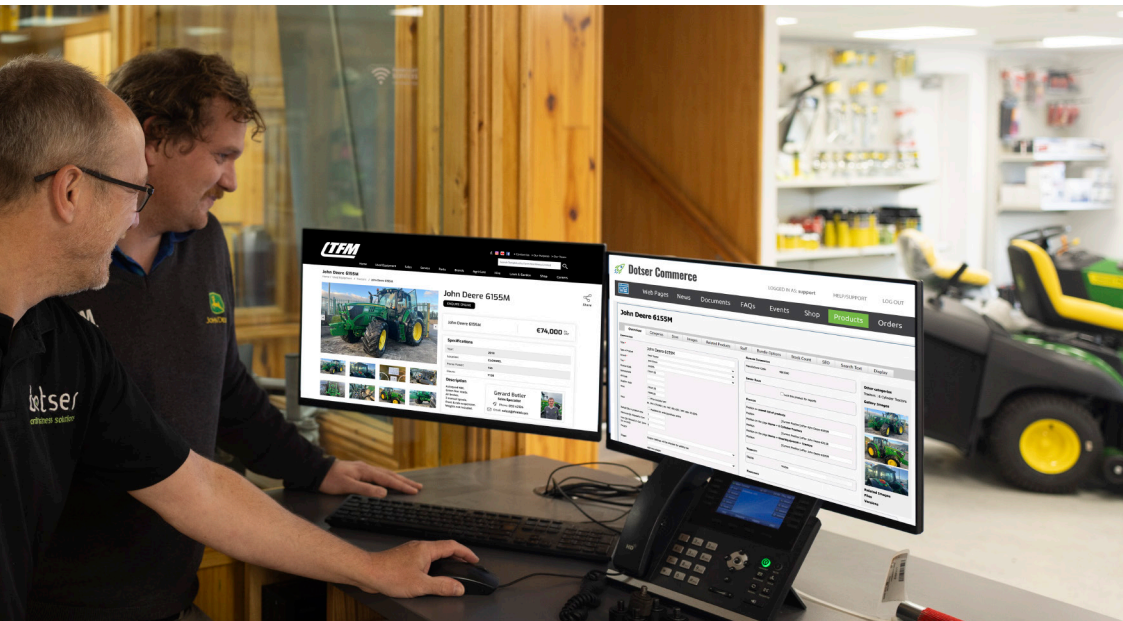



















**Leading provider of integrated eCommerce solutions in the Agri Sector**

**dotser**

[www.dotser.com](http://www.dotser.com)



## INDEX

	One Central Platform	04-05
	Dotser Process	06
	Project Management	07
	Content Management System (CMS)	08-11
	Product Information Management (PIM)	12-17
	New / Used Machinery	18-19
	Machinery / Parts / Merchandise Management	20-21
	Quotation / Ordering / Shopping Cart Management	22-23
	Improve Efficiencies	24-25
	Online Transactions & Order Management	26-29
	Payment Gateways	30
	Secure Cloud Hosting	31
	Layout & Design	32-33
	Search Engine Optimisation	34-35
	Training & Support	36-37
	Clients	38-47
	About Us	48
	Meet Your Team	49



## One Central Platform

### ■ Integrate multiple systems

Bring together data from different systems into a simple secure view with the ability to drill down to specific details

### ■ Automate processes

Optimise business workflow and improve data integrity by reducing manual tasks, human error and administration costs

### ■ Secure data control

Control who sees what data in your organisation. Specify user roles for departments and management levels with forensic audit logs.

### ■ Access to live information

Real time access to factual data - central place of truth

### ■ Make better decisions

Increase confidence across all teams, reduce frustrations, resolve issues faster, improve customer service and portray best practice business principles.



## Mobile First

### ■ Fast secure access using smartphone

### ■ Simple user friendly interface

### ■ Access on any devices, operating system, web browser



## Give your team secure fast access to reliable live data

- Products - Codes, brands, descriptions, images, videos, specifications, manuals & files.
- Whole goods / machinery - Serial #, reg, hours, details, images, status - 'for sale' / 'sold'.
- Stock availability - Quantities in warehouse, depots, bin / area / location.
- Supplier / distributor levels - Days to delivery - 'Next day' / '3 days' / '7 days'.
- Pricing - Retail (B2C), trade (B2B), dealers. Only registered / approved users to view set pricing. Apply markup to cost pricing, RRP, to display relevant sales price.
- Marketing campaigns - Set special offers, timed campaigns - start end date
- Bulk discounts applied to product category, sub category & brand combinations.
- Customers - Contact, CRM, Retail/B2B, price contracts, quantity breaks. trade discounts.
- Orders - Quotes, orders, fast repeat ordering, sales history, delivery tracking.
- After sales - Warranties, servicing, maintenance, annual licence, parts

### PRODUCTS

Receive live product information from suppliers

Display directly on your ecommerce website

### INVENTORY

Receive live stock updates from suppliers

Share with internal sales team & trade customers



### PRICING

Receive live cost price from supplier  
Control sales price / apply margin in bulk

### FINANCIAL

Accounting Integration  
Live Order / Payment Information

### FULFILMENT

Dropshipping integration  
Live consignment tracking



## ↻ Dotser Process



### Learn

Gathering as much information at the beginning helps us to understand your business goals. We will ask questions to learn more about your business.

### Design

With your input, we will devise a visual style and structure for your online business



### Develop

Create a blank shell system on our secure hosting platform and implement the agreed design and custom elements

### Test & Train

Test system elements, provide online access and train appointed users in the CMS



### Launch

Complete launch procedure to ensure smooth system implementation with scheduled post-deployment.

# Project Management

Efficient project management is crucial to completing the goals and objectives of the project and to determine when the various project components are to be completed.

With over 20 years experience, Dotser have developed a real understanding of our customer needs and have earned a proven track record delivering results on time.

The diverse team at Dotser consists of individuals with different backgrounds and experience fostering creativity and excellent problem-solving capabilities. Using the best project management software enable Dotser to streamline project workflows, enhance collaboration and productivity.

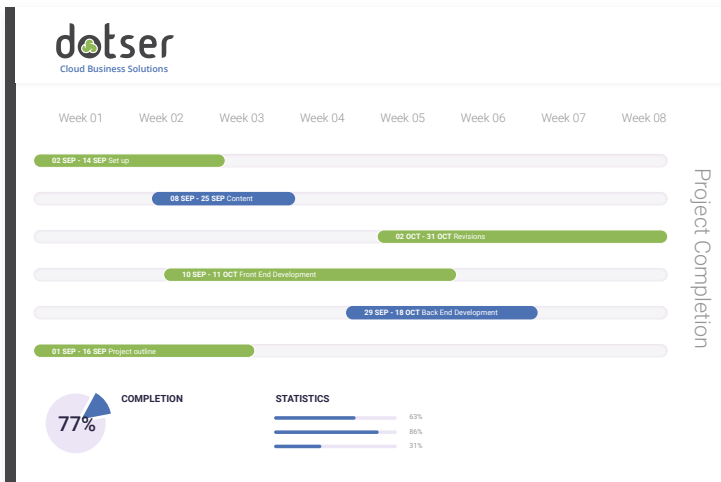

We use Jira Project Management Software to ensure your project is delivered as agreed.



## Content Management System (CMS)

The Dotser Content Management System is designed to simplify uploading and editing your website content.

Dotser CMS allows you to:

- Control your website's structure (pages & subpages)
- Enter/edit content (text & images)
- Receive help and support from the Dotser helpdesk

### Page Structure

- User-friendly page-structuring
- Add/remove/order pages & subpages
- Hide/block pages

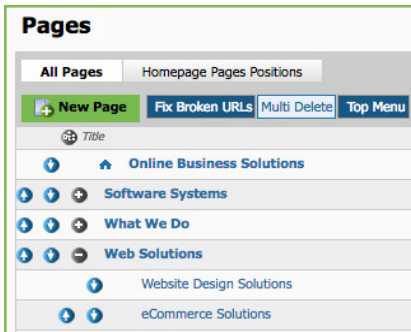

### Web Pages

Easily input & update text.

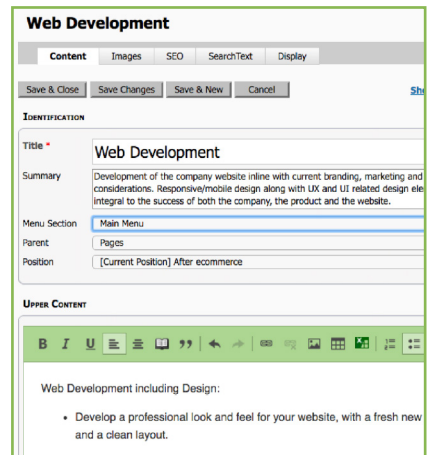



## Desktop



## Tablet



## Mobile





## Imagery & Content

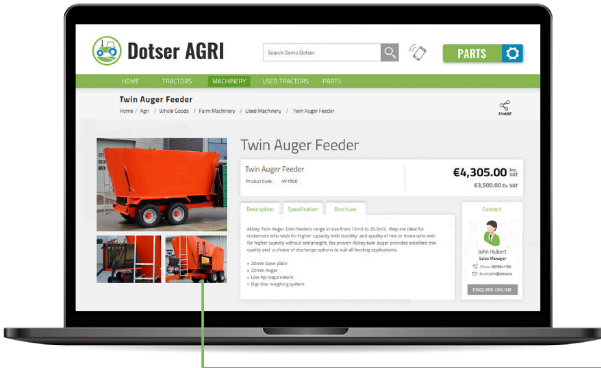

### Upload Product Images

(101 KB, 1200 x 628)  
 Name: Twin Auger Feeder.jpg  
 Caption Title: Twin Auger Vertical Diet Feeder  
 Caption Text: Capacity without extra height  
 Link: dotseragri/products/feeder  
 Target: Twin Auger Vertical Diet Feeder  
 Hover Text: Vertical Diet Feeder  
 Alternative Text: Vertical Diet Feeder

(107 KB, 1200 x 628)  
 Name: Abbey VF1500 Twin Auger Feeder Rear View.jpg  
 Caption Title: Twin Auger Vertical Diet Feeder  
 Caption Text: Capacity without extra height  
 Link: dotseragri/products/Feeder  
 Target: Twin Auger Vertical Diet Feeder

### Easily Edit Fields

- Name
- Caption Title
- Caption Text
- Link
- Target
- Hover Text
- Alternative Text

**Crop an image** Ratio set to 5 x 3. Width:  Height:

### Easily crop an image

# ⚙️ Sharing Content to Social Media

## Keep Your Customers Informed by Adding News / Blog Articles

Dotser CMS allows you to post news/blog items which improves engagement, eg. industry news, product updates & press releases.

**New Payment Gateway gets Dotsers approval**

General Images Social Share Image Files Display

Save & Close Save Changes Save & New Cancel

**IDENTIFICATION**

Title \*

**OPTIONS**

Summary

Display

Status

Type

Published

**CONTENT**

**B I U** [List Icons]

The best payment gateways provide a simple way to take and process credit card payments online.

Payment gateways offer the flexibility of being able to take card payments

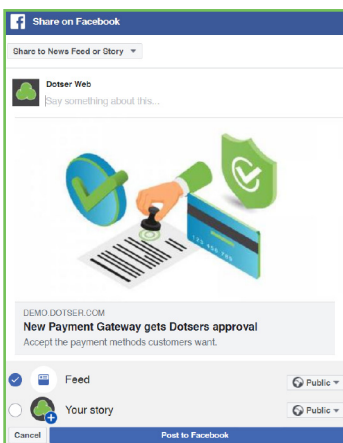
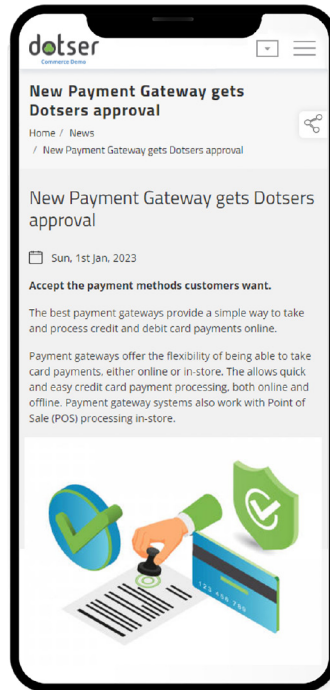

## Share on Popular Social Media Platforms





## Product Information Management (PIM)

### Easy-to-use product management database

- Add items by title, code, type, description, image & price
- Assign products to multiple categories
- Add variants to products, which are displayed in product detail
- Select related products & recommended accessories
- Bulk upload images to a product
- Highlight featured products

Overview	Categories	Images	Related Products	Staff	Var
Save & Close	Save Changes	Save & New	Cancel		
<b>IDENTIFICATION</b>					
Title *	Twin Auger Feeder				
Type of Product	Machinery				
Brand *	Firm Agri				

- Easily Add Product Title & Select Brand

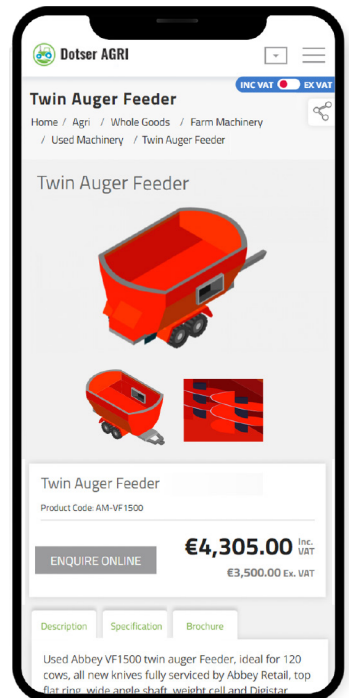

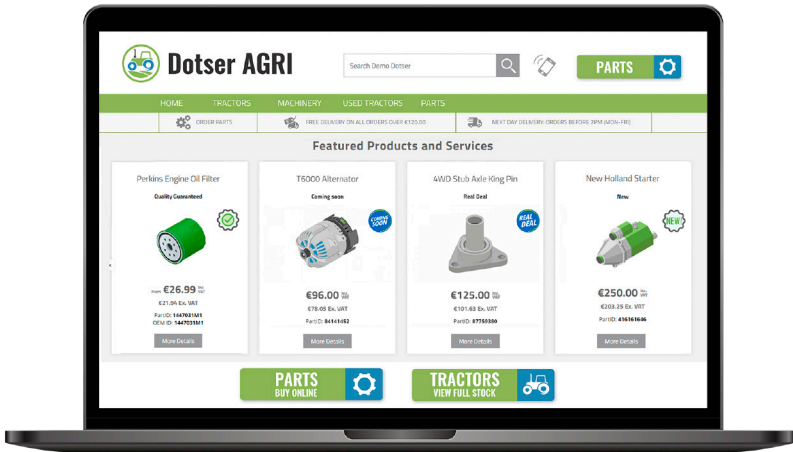

## Manage 1000's of products

Easy-to-use product management database

Live stock integration

**Products**

HEADS UPI You are updating a LIVE environment! Be careful

Filter View **List View** Custom Product Types Bulk Special Offers Download Display Settings Related Products Settings Homepage Display Locations Products Out of Stock Special Offers Settings Upload Prod

**Add New** Fix Broken URLs | 20 50 100 All | Multi Delete | Shop for Customers

Showing all 83 records

Machinery Merchandise Online Course Parts Software Standard Products Used Machines

Category: Pages Brands: (All brands) Staff: All Staff Visibility: All (no filter) Name: Product Code:

Uncategorised	No Description	No Image	Special Offer Active	Special Offer Expired	Featured Product	Missing Meta Description or Keywords	Missing Product Code											
Show All	Link	Image	Title	Brand	Stock	Purchase	Product Code	Product Type	Tax Rate	IncEx VAT	Price	Special Offer	Featured					
			Massey Ferguson 5455	Jumbo	1	Disabled		Used Machines	23.00 %	Inc. VAT	€1,234.00	€1,200.00	No					
			New Holland Starter		4	Disabled		NH-STARTER	23.00 %	Inc. VAT	€250.00	[offer expired] (til 1 Feb)	No					
			2000R Premium 28.1 X 26 WHEELS	Firm Ag	2	Enabled	WH3653	Parts	23.00 %	Inc. VAT	€8,999.00	[offer expired] (til 17 Mar)	No					
			Abbey VF1500 Twin Auger Feeder	Firm Ag	0	Disabled	AM-VF1500	Machinery	23.00 %	Inc. VAT	€3,500.00		No					
			Airfer Fertilizer Spreader	Firm Ag	Unknown	Enabled		Used Machines	23.00 %	Inc. VAT	€0.00		No					
			↳ 1 Ton	Firm Ag	10	Enabled		Used Machines	23.00 %	Inc. VAT	€1,500.00		No					
			↳ 2 Ton	Firm Ag	6	Enabled		Used Machines	23.00 %	Inc. VAT	€2,500.00		No					
			Show ticket	Firm Ag	70	Enabled		Standard Products	23.00 %	Inc. VAT	€20.00	€15.00	No					
			↳ Gold - After party admission	Firm Ag	52	Enabled		Standard Products	23.00 %	Inc. VAT	€40.00	€40.00	No					
			↳ Platinum - After party admission	Firm Ag	14	Enabled		Standard Products	23.00 %	Inc. VAT	€50.00	€50.00	No					
			Masks	ABC Enterprises	987	Enabled	FM2000	Standard Products	23.00 %	Inc. VAT	€100.00	€90.00 (til 17 Sep)	No					



## Product Information Management (PIM)

### Manage Special Offers

Choose which special offer products to display on homepage

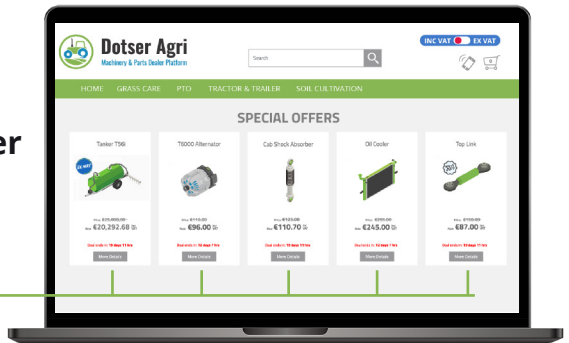

#### SPECIAL OFFER

##### Special

Enable Special Offer

Price:

Special Offer Begins

July

24 - Wednesday

2024

00:05

Special Offer Expires

August

01 - Thursday

2024

00:00

##### Featured

Featured Product

[Offer Valid while Stocks Last](#)

##### Extra

Enable Extra Text

Set count down on special offer time availability



#### Cab Shock Absorber



[Add to wishlist](#)

Price: **€123.00**

Now **€110.70** inc. VAT

**€90.00 Ex. VAT**

Deal ends in: **9 days 11 hrs 23:18**

[More Details](#)

## ■ Easily turn VAT on/off display

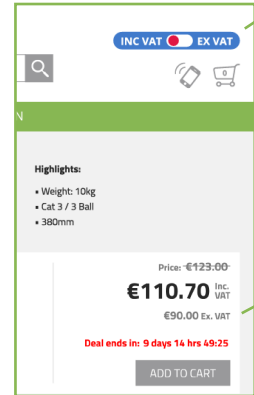
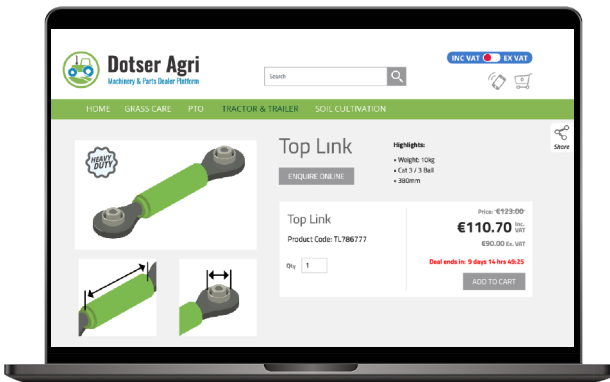

## ■ Add Sticker graphics to products





## Parts Catalogues Diagrams

Easy-to-use detailed parts diagrams corresponding to the details with an add to cart function.

- Search the the illustrated parts catalogue to find the part
- User-friendly, select the part from the diagram and add to cart
- Clearly laid out and structured so the part is easily found

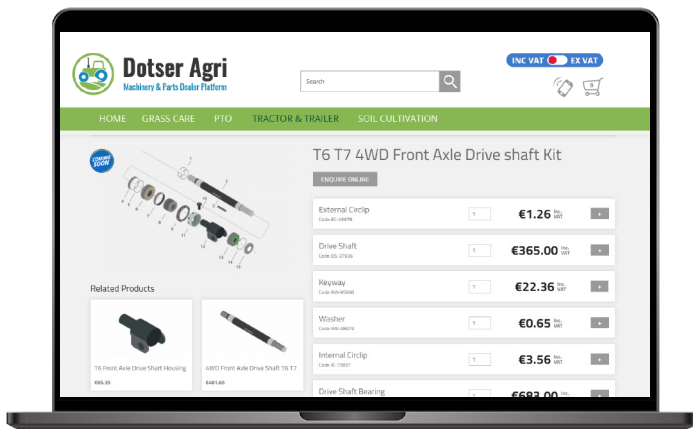

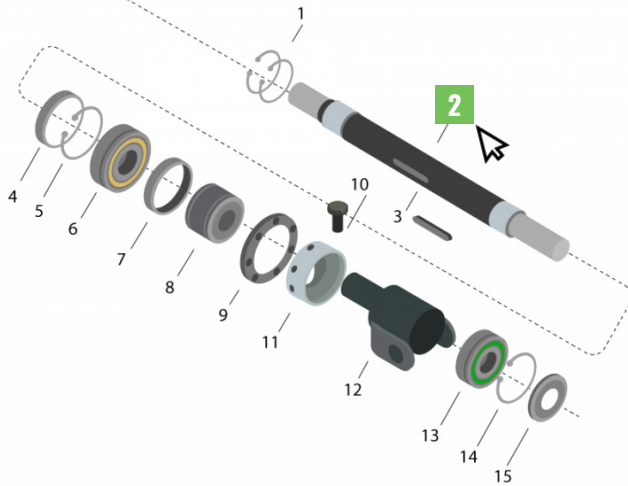

## T6 T7 4WD Front Axle Drive shaft Kit

1	External Circlip Code: EC-45678	<input type="text" value="1"/>	<b>€1.26</b> Inc. VAT	<input type="button" value="+"/>
2	Drive Shaft Code: DS-27656	<input type="text" value="1"/>	<b>€365.00</b> Inc. VAT	<input type="button" value="+"/>
3	Keyway Code: KW-95968	<input type="text" value="1"/>	<b>€22.36</b> Inc. VAT	<input type="button" value="+"/>
4	Washer Code: WR-08979	<input type="text" value="1"/>	<b>€0.65</b> Inc. VAT	<input type="button" value="+"/>
5	Internal Circlip Code: IC-79897	<input type="text" value="1"/>	<b>€3.56</b> Inc. VAT	<input type="button" value="+"/>
6	Drive Shaft Bearing Code: DSB-909123	<input type="text" value="1"/>	<b>€683.00</b> Inc. VAT	<input type="button" value="+"/>
7	Nut Code: NT-23196	<input type="text" value="1"/>	<b>€0.36</b> Inc. VAT	<input type="button" value="+"/>
8	Drive Shaft Bearing 2 Code: DSB2-450994	<input type="text" value="1"/>	<b>€64.21</b> Inc. VAT	<input type="button" value="+"/>





## New / Used Machinery

### Full control over machine information

Enter specifications into custom fields

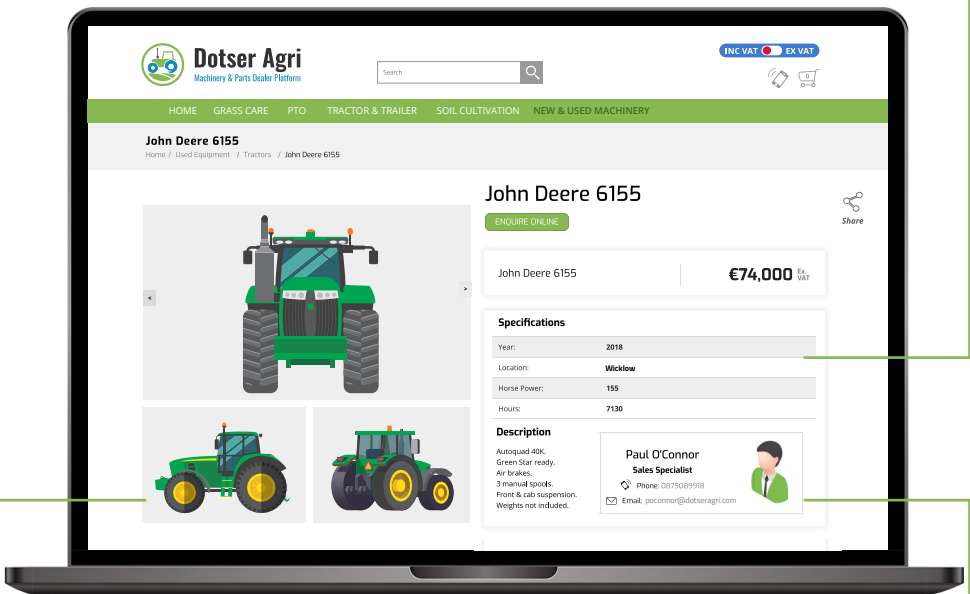

Upload multiple images

Highlight the relevant sales person responsible for each machine

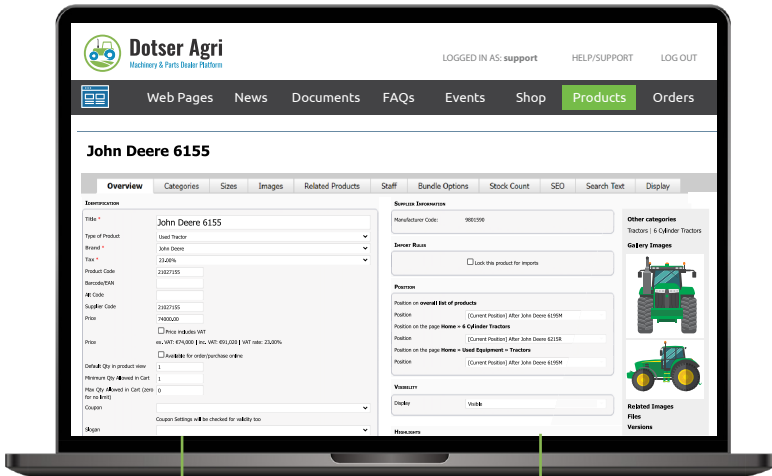

**IDENTIFICATION**

Title \*

Type of Product

Brand \*

Tax \*

Product Code

Barcode/EAN

Alt Code

Supplier Code

Price

Price includes VAT

Price

Available for order/purchase online

Default Qty in product view

Minimum Qty Allowed in Cart

Max Qty Allowed in Cart (zero for no limit)

Coupon

Coupon Settings will be checked for validity

Slogan

**SUPPLIER INFORMATION**

Manufacturer Code:

**IMPORT RULES**

Lock this product for imports

**POSITION**

Position on overall list of products

Position

Position on the page Home » **6 Cylinder Tractors**

Position

Position on the page Home » **Used Equipment » Tractors**

Position

**VISIBILITY**

Display

**HIGHLIGHTS**

**Other categories**  
Tractors | 6 Cylinder Tractors

**Gallery Images**

**Related Images**  
Files  
Versions



## Machinery / Parts / Merchandise Management

**Point of Sale and eCommerce  
in one central system**





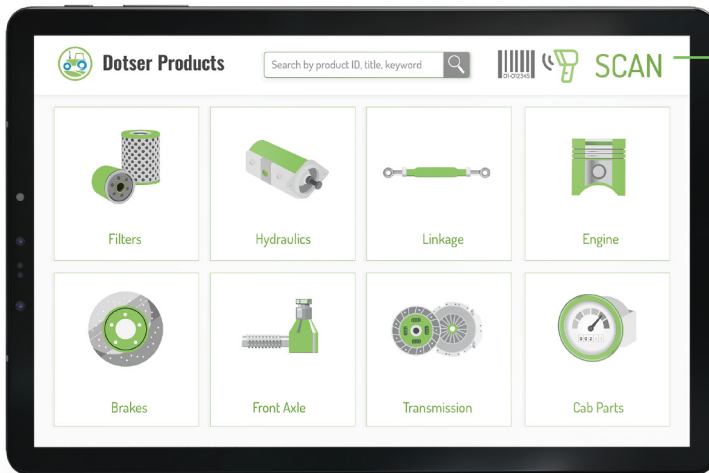

### ■ Search parts & stock availability



### ■ Scan by barcode

## Simple fast navigation

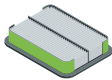

■ Search and filter by part id, brand, category, sub category and title

<p>HYDRAULIC FILTER</p>  <p>Code: 16146133</p> <p><b>€54.56</b></p> <p>ORDER NOW</p>	<p>HYDRAULIC FILTER</p>  <p>Code: 8745646</p> <p><b>€59.89</b></p> <p>ORDER NOW</p>
<p>CAB AIR FILTER</p>  <p>Code: 87465464</p> <p><b>€64.56</b></p> <p>ORDER NOW</p>	<p>OUTER AIR FILTER</p>  <p>Code: 87568864</p> <p><b>€89.89</b></p> <p>ORDER NOW</p>

 **Dotser Products**

---

**Checkout**

	<p>HYDRAULIC FILTER <span style="float: right;">x</span></p> <p>Qty: <input type="text" value="1"/></p> <p>Unit Price: €54.56 Amount: €54.56</p>
	<p>CAB AIR FILTER <span style="float: right;">x</span></p> <p>Qty: <input type="text" value="3"/></p> <p>Unit Price: €64.56 Amount: €193.68</p>
	<p>OIL FILTER <span style="float: right;">x</span></p> <p>Qty: <input type="text" value="1"/></p> <p>Unit Price: €40.55 Amount: €40.55</p>

SUB-TOTAL: €288.79  
TOTAL VAT: €57.76  
**TOTAL VAT: €346.55**

<a href="#">Print</a>	
<a href="#">Pay With Credit Card</a>	<a href="#">Pay With Paypal</a>
<a href="#">Add More Products</a>	<a href="#">Place Order</a>
<a href="#">Terminal</a>	<a href="#">Cash</a>



## Quotation / Ordering / Shopping Cart Management











### Allow user to add product items to shopping cart & submit orders

- Add to cart / order now facility to create online order
- Guest Checkout - allow ordering without having to create an account
- Manage shipping rates, countries and VAT rate
- Assign different shipping rates to different products
- Set shipping rates based on country delivery location
- Click & collect at multiple locations

### ■ Delivery Information

- Add Shipping Costs
- Select Shipping Country



Shipping			
Shipping Costs		Card Fees	
<a href="#">Add New</a>			
Showing all 10 records			
Title	Countries	Shipping Cost	
 Ireland	IE	€7.80	
  Free Shipping	GB	€0.00	
  United Kingdom	GG, IM, JE, GB	€59.99	
  Free Shipping	GB	€0.00	
  EU	AT, BE, BA, BG, HR, CY, CZ,...	€39.99	
  USA	US	€59.99	

## Simple fast add to cart and checkout process

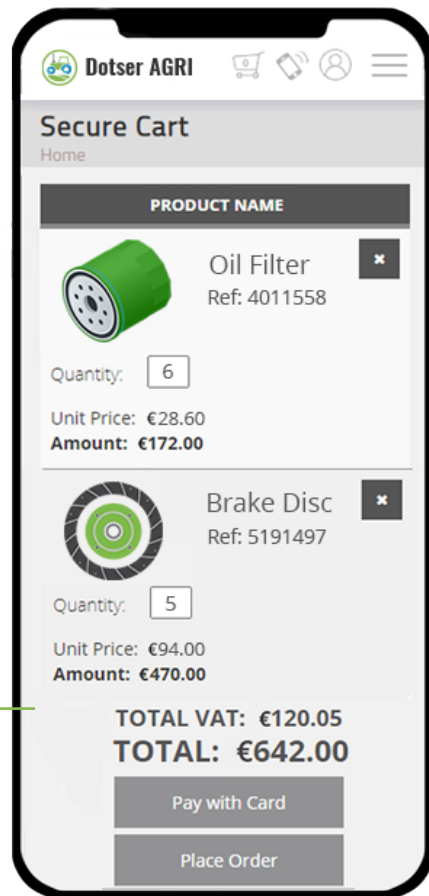

### Add To Cart / Order Now

Guest Checkout with Optional  
Credit Card or PayPal



## Online Transactions & Order Management

### Enable secure online transactions with the facility to view & manage orders

- Submit online order to bank for payment verification and processing
- Email sent to buyer and sales team with order confirmation and detail
- Database of new and historical orders saved in central system
- Manage status of individual orders (*dispatched, delivered, create your own*)
- Integration with Realex, RMS and PayPal (*account required*)
- Simple invoice receipt
- Customers can view order details and history
- SSL Certificate registration

Verified by  
**VISA**

**MasterCard**  
SecureCode™



## ■ Payment Gateway Integration

### Shop Settings

General
Internal Checkout Configuration

Apply and Close
Apply Changes
Cancel

**PICK YOUR PAYMENTS PROVIDER**

**Stripe**  
 **Opayo**

**LIVE STRIPE ACCOUNT**

Merchant ID	somecompany
Account	onlinesalest
Secret	10987654321a

**TEST STRIPE ACCOUNT**

Merchant ID	somecompany
Account	onlinesalesp
Secret	10987654321a

### Shop Settings

General
Internal Checkout Configuration
PayPal Configuration

Apply and Close
Apply Changes
Cancel

**PAYPAL INTEGRATION (REAL MODE)**

PayPal ID	123456789
PayPal E-Mail	acompany@gmail.com

**PAYPAL INTEGRATION (TEST MODE)**

PayPal ID	123456789
PayPal E-Mail	acompany@gmail.com



## ■ SSL (Secure Socket Layer)

Certificate Registration with Industry-Standard Security.

SSL ensures that all data passed between the web server and browser remains private.

**SSL**

No, we don't have a valid certificate  
 Yes, we have a valid SSL certificate

Only one version of each page (SSL or not) (Use this option only if some pages reference non-secure external content)  
 Some pages force SSL, others allow either  
 Force all pages to be SSL

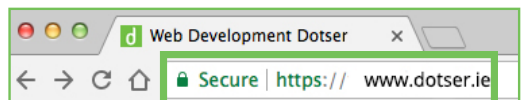



## Improve Efficiencies - Save Time And Money - Sell More Machinery And Parts

Dotser Agri software allows you integrate multiple systems into one central platform ensuring all your team have secure access to live product, stock, pricing, order and customer data from any mobile device.

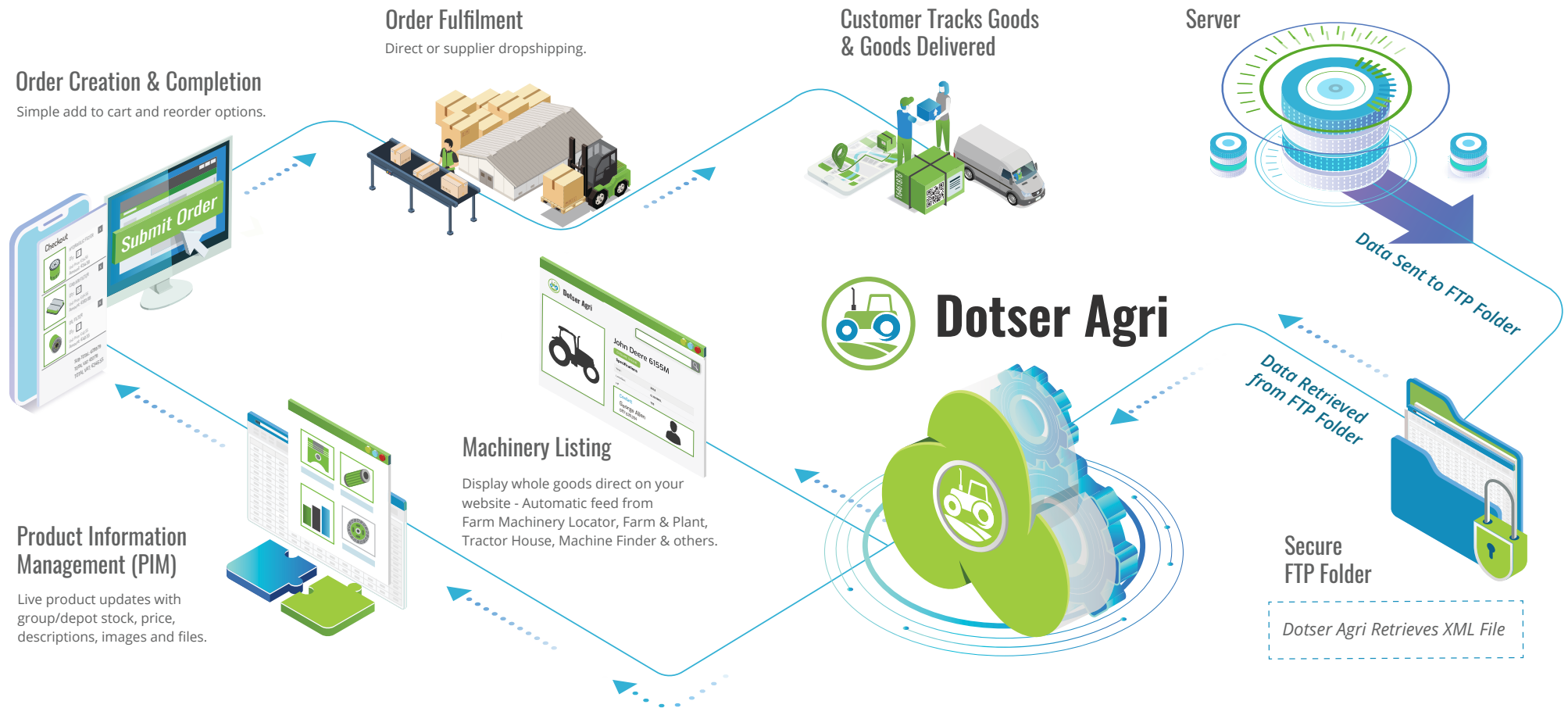



## Order Management System

**Orders**

List of Orders | Order Statistics | Transaction History | Download Orders | Summary

[Add New](#) | 20 | 50 | 100 | 500 | All | [Clear Filters](#)

Showing records 1 to 50 of 1150

[All statuses] | **Ordered** | Dispatched | Completed | Refunded | Cancelled | Test Order

Order ID / Ref:  Name:  E-mail:  Order Value: (All values) Order Mode: All Modes From: dd/mm/yyyy To: dd/mm/yyyy

Item Type: All Types General Product: All Products

[All transactions] | Successful transactions | Failed transactions

ID	Bill	Ship to	Method	E-mail	Country	Payment	Order Made
P1441	Annemarie Kearney	Annemarie Kearney	Free Shipping over €100 (€0.00)	annemariekearney@gmail.com	Ireland	<span>S</span> Stripe	14:05 7 Nov 2023
P1439	Colm O Rourke	Colm O Rourke	Free Shipping over €100 (€0.00)	colmorcon@gmail.com	Ireland	<span>S</span> Stripe	21:16 6 Nov 2023
P1436	Sean Scannell	Sean Scannell	Standard (€10.00)	seansca045@gmail.com	Ireland	<span>S</span> Stripe	23:41 3 Nov 2023
P1435	Kalyn Morris	Kalyn Morris	Free Shipping over €100 (€0.00)	kalynjmorris@gmail.com	Ireland	<span>S</span> Stripe	21:44 3 Nov 2023
P1433	Maria Gallagher	Maria Gallagher	Standard (€10.00)	mariaagallagher6253@gmail.com	Ireland	<span>S</span> Stripe	14:37 2 Nov 2023
P1431	Evelyn OCarroll	Evelyn OCarroll	Standard (€10.00)	evelynocarroll@hotmail.com	Ireland	<span>S</span> Stripe	14:18 2 Nov 2023
P1430	bernard mullaney	bernard mullaney	Standard	mullaneybernard@gmail.com	Ireland	<span>py</span> unverified Completed	21:33 1 Nov 2023
P1429	SHIRLEY BENNETT	SHIRLEY BENNETT	Standard (€10.00)	shanebennett@btopenworld.com	Ireland	<span>S</span> Stripe	16:55 31 Oct 2023
P1428	GERALDINE O'DRISCOLL	GERALDINE O'DRISCOLL	Standard (€10.00)	geraldine@collexperts.ie	Ireland	<span>S</span> Stripe	10:03 31 Oct 2023

### Customer Account Details

My Account

Geoff Liffey

[Edit Profile](#)

[Change my password](#) | [Change Email Address](#) | [Delete my account](#)

**Recent activity**

Shopping Cart | You have 3 items in your shopping cart.

Orders | You have 3 orders so far.

**Billing Address**

Name	Geoff Liffey
Address	Ardrone
Town	Birr
County	CO. OFFALY
Country	Ireland

[Edit Billing Address](#) | [Copy to Shipping](#) | [Delete](#)

### Easy-to-use Order management System

**Order P1441**

[Show card processing details \(Success\)](#)

[Show transaction details \(Success\)](#)

**ORDER STATUS**

Order Status \*

Status Customer Secs \*

Customer E-mail

[Resend Order Confirmation](#)

[Issue Full Refund](#) | [Issue Partial Refund](#)

**LABELS**

[Generate Shipping Label](#)

[Generate Return Label](#)



# Invoicing

Order 1XE8 received Thu, 9 Nov 2023, 11:27

From: **Declan Agri** <declan@dotser.com>  
 Date: Sat, 4 Nov 2023 at 11:15  
 Subject: Order 1XE8 received from Declan Leonard  
 To: <dotser@dotser.com>, <dotser@dotser.com>, <dotser@dotser.com>

received an order for the total of €170.00. Order reference: 1XE8.  
 To view the order details, go to [/admin/orders\\_dhc7dfc33](#)

Order Details		Shipping details	
Order Made:	11:14 4 November 2023	Type:	Ireland (€9.00)
Current Status:	Ordered	Amount:	€9.00
Order Reference:	1XE8		

Billing Address		Shipping Address	
Declan Leonard Broughal BIRR OY R42W012, Ireland		Declan Leonard BIRR OY R42W012, Ireland Phone: +353(0)12568 987 712 E-mail: <a href="mailto:dotser@dotser.com">dotser@dotser.com</a>	

Description	Product Code	EAN/Barcode	Qty	Price (ex. VAT)	VAT	Amount
Accumulateur simple	4293526M92		1	€130.89	23%	€161.00

## Order Confirmation emails

## Easily create customer invoices

**Dotser AGRI**  
- E-COMMERCE

INVOICE TO  
Eric Clemence  
285 North Street, Widdowater  
ericclemence@pplphoton.com  
+3538 12568 987 712

**INVOICE**  
Invoice Number : 123456789  
Invoice Date : 10/10/2021

**PAYMENT METHOD**  
Account No : 123456789  
Account Name : RICE  
Branch Name : RICE

Item	Price	Qty	Total
Cat3 Top Link T7000	€850.00	01	€850.00
Left Hand Link Arm TM 125	€150.00	02	€300.00
PTO Gear TM 150	€300.00	02	€600.00
PTO Shaft TM 125	€250.00	02	€500.00
Right Hand Link Arm TM 125	€150.00	05	€750.00

TERMS & CONDITION	SUB TOTAL	€300.00
TAX: VAT 10%	€300.00	
DISCOUNT 5%	€165.00	
<b>GRAND TOTAL</b>	<b>€3165.00</b>	

## Automatically Create Packaging Labels

**CMR DHL PARCEL CONNECT**

Dotser Agri  
New Business Park, Tullamore, Co Offaly, Ireland

Declan Leonard  
Birr  
Co. Offaly  
R6SR4N2

Bill of number: 12345678901234567890  
 Shipper Ref.: 12345678901234567890  
 Customer Ref.: Declan Leonard  
 Contact: 12345 6789



## Payment Gateways

### Multiple Payment Options

**Allow customers choose how they want to pay - secure shopping cart with multi payment gateways.**

Customers can pay for products and services using a secure shopping cart system and reputable payment gateways from leading payment providers.



**Dotser work with Stripe software in order to accept payments and manage businesses online.**

Whether you're looking to bill customers on a recurring basis, set up a marketplace, or simply accept payments, Stripe is the leading fully integrated, global platform that can support online payments.

## Secure Cloud Hosting

### Secure & Server Databases

Cloud hosting and storage is a critical component of an effective online business and digital strategy. Dotser's experience in providing a secure and resilient cloud infrastructure to host your business solution ensures your system is always online.

Dotser uses a complete range of cloud storage services to support both application and archival compliance requirements and our partnership with world leaders in cloud technologies ensures we offer reliable, scalable, and secure solutions.

### Back up Policy

Dotser has the ability to recover, restore and retrieve data that is lost/damaged/compromised to meet regulatory backup compliance requirements.

*Cloud Partners*





## Layout & Design

The creative team at Dotser are here to assist you in developing and designing your website.

The Dotser team will:

- Create the website layout and design in line with company branding
- Implement your brand font and colour scheme (*style sheet*)

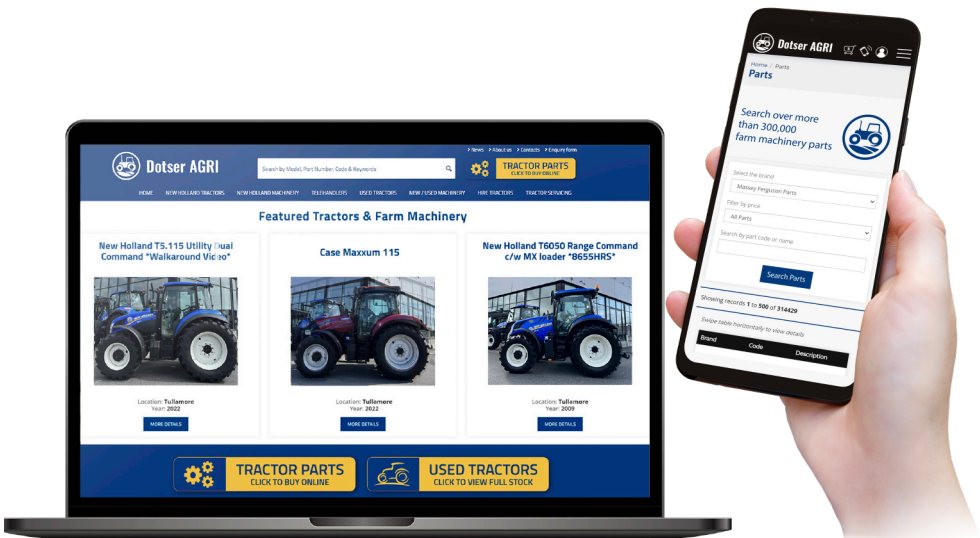

## Brand Identity / Customisation

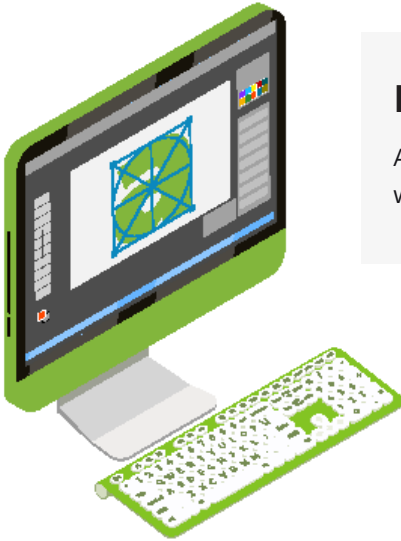

### Logo Customisation Service

As part of our service Dotser will provide you with a number of logo customisations.

Dotser will develop your logo to compliment your website and provide you with a strong brand message, allowing you to promote your business in order to generate sales.

### Logo/Brand Refresh

Update of your business logo for use on your website and in your marketing material





## Search Engine Optimisation (SEO) Tool

At Dotser we pride ourselves on achieving high organic rankings for our clients on Google, which delivers the best return on your marketing investment.

- Search engine-friendly URL's
- Simple to use module to manage page title, descriptions and keywords
- Proven to deliver results for competitive keywords
- Natural, organic rankings attract more attention

Applying SEO expertise to provide high rankings in organic search results consistently outperforms the return on paid search advertising.

**This fact alone is why Dotser's SEO expertise can be a valuable weapon in your online arsenal.**



### Organic/Natural Search Results

Tools to Compete with International Brands  
Paying Large Amounts on Google Adwords

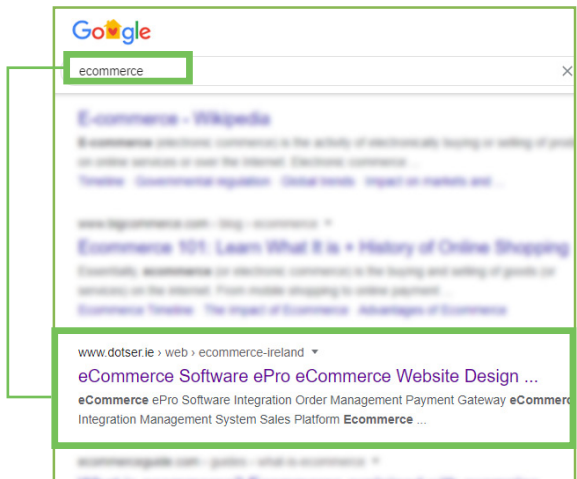





**Dotser Agri is integrated with the latest Google Analytics tools (GA4) to give important insights into website user behaviour**

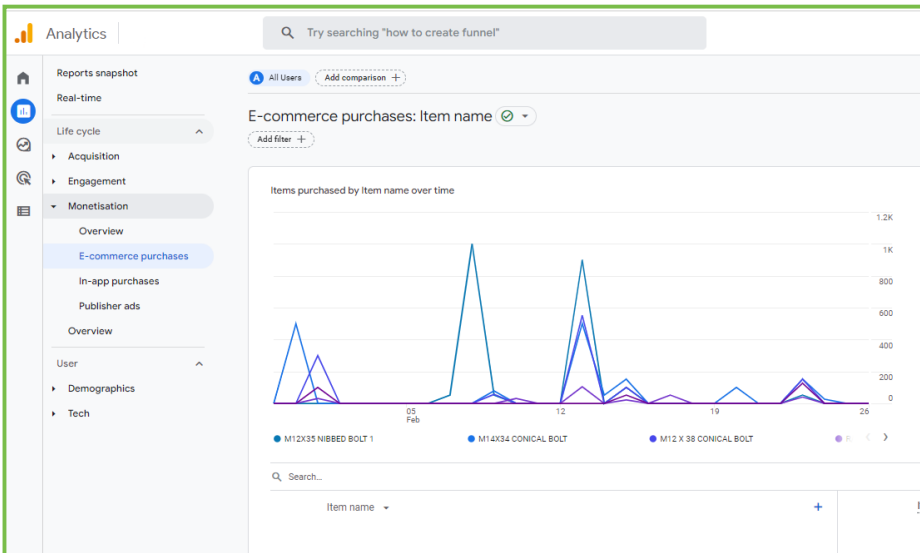

## E-Commerce purchases data

E-commerce purchases by item name - includes items viewed, items added to the cart, items purchased and revenue



## Training & Office Hours Support

**With Dotser you can avail of the team's help and support with:**

- Web & marketing advice
  - Live online training
  - Email support
- Phone helpline available from 9am to 5pm, Monday to Friday

Home

### Dotser Service Desk - My Requests

Search Requests Category

Status

View All (23)  Awaiting Dotser Review (1)  Waiting For Customer Info (0)  Customer Info Received (0)  Approved (0)

Scheduled For Development (0)  In Progress (5)  Approved By Customer (0)  Closed - No Issue or Can't Reproduce Issue (1)

Solved - Waiting For Customer Review (2)  Resolved (1)

[Create a new query](#)

Service Desk Issues

Reference	Title	Type	Status	Priority	Submitted	Last Updated
DSD-729	Test Andres Update Webhook	Technical Support	In Progress	Low	24/02/2023	24/02/2023

## Support Services

- Fast & efficient helpdesk support
- Our team have the ability to remotely control your computer for trouble shooting & training
- Knowledge base
- Download guide
- Guidance in setting up email with purchased email services
- Helpdesk support
- Online support requests managed in one place
- Quick-response turnaround

### Software

Google Apps



TeamViewer



slack

JIRA Service Desk



Microsoft Teams



zoom



Google Meet



## Leading provider of integrated eCommerce solutions in the Agri Sector

Proudly powering



TEMPLETUOHY FARM MACHINERY LTD.



**MID LOUTH GARAGE**  
SALES • PARTS • SERVICE

- AGRICULTURAL MACHINERY DEALERS
- AGRI PARTS DEALERS
- OEM MANUFACTURERS





## Leading provider of integrated eCommerce solutions

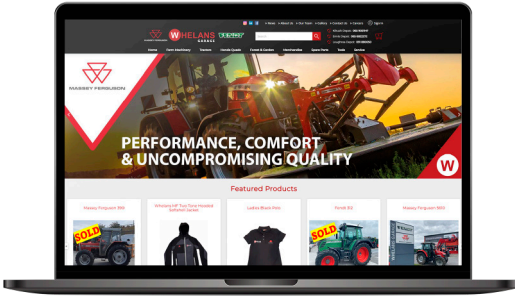

JOHN DEERE



MASSEY FERGUSON



- Agricultural Machinery Dealers
- AgriParts Dealers
- OEM Manufacturers

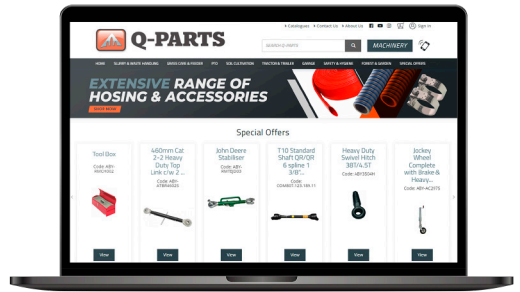
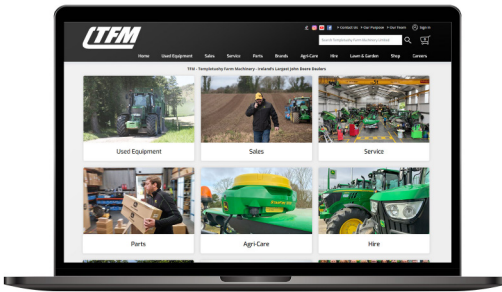



## Client Testimonial



Dotser developed a comprehensive online resource for Whelan's Garage. Through the Dotser Agri API integrating with IBCOS, product information is automatically updated. This ensures an engaging experience for site visitors as well as improved shipping processes.

This solution coupled with the use of the Dotser Agri Content Management System (CMS), has provided for significant SEO improvements, resulting in increased sales of Massey Ferguson merchandise, greater brand awareness and more sales enquiries based on product code searches.

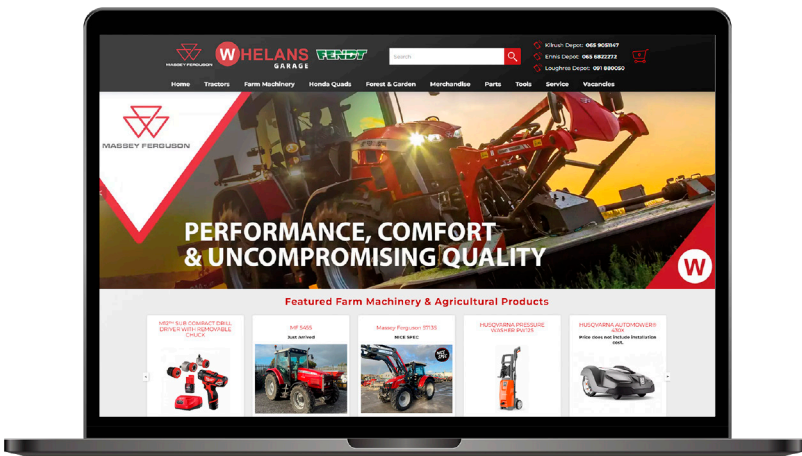



*AUTOMATE, INTEGRATE and SCALE are Dotser's three descriptive words for their business offering, and that is exactly what the Dotser's software and integration solution enabled us to do.*

*We first approached Dotser looking for an ecommerce and website management platform, and then a solution to integrate with our IBCOS dealer management system.*

*Dotser's systems and software has enabled us to automate our stock updates, reduce costs, and scale the business. We find Dotser very approachable, skilled and solution-orientated, always providing a solution for any concern we have.*

*I have no hesitation in recommending Dotser and their Dotser Agri platform to any agri dealer out there.*

Kevin Whelan  
**Owner, Whelan's Garage**





## Client Testimonial



# Q-PARTS

**Leading supplier of wearing and fast-moving parts for the agricultural machinery sector around the world choose Dotser Agri.**

System is integrated directly with Abbey's ERP system (M1 from ECI solutions). Enabling registered and approved customers to view live product pricing and stock information, allowing them place orders direct from a simple-to-use mobile responsive front-end.

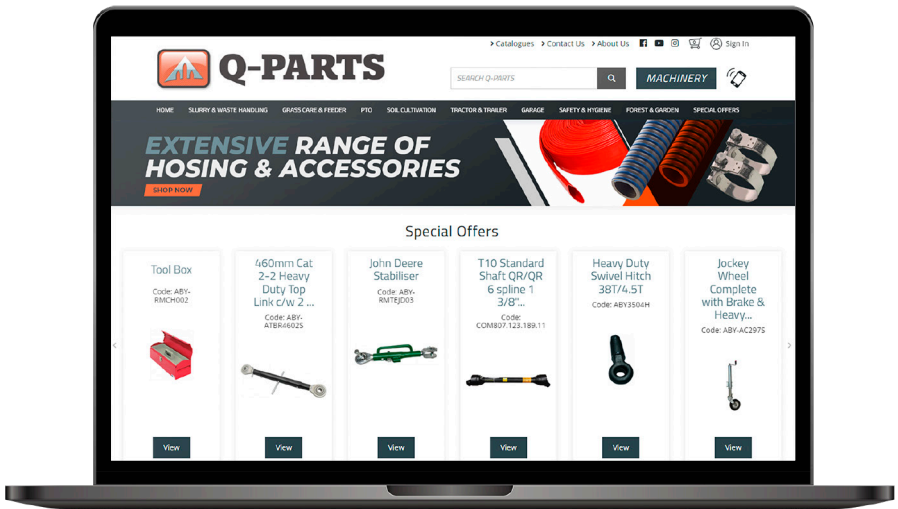

*“Abbey Machinery engaged with Dotser to provide an eCommerce solution; in particular, a webshop for our QParts division to our customer base. The webshop had to integrate with our ERP system — m1 by eci.*

*Dotser successfully delivered the brief which is now our QParts product - [www.abbeyqparts.com](http://www.abbeyqparts.com)*

*The end result is an easy-to-use platform, delivering sales, with the required information for business analysis.*

*We’ve been using the system for two years now (since September 2020), and with the very positive feedback both from our customers and staff alike; Abbey Machinery are very happy with the finished product and continuing service.”*

Cormac Cavanagh  
**Supply Chain Manager**



Integrated with



**eci**<sup>TM</sup>

**M1**<sup>®</sup>



TEMPLETUOHY FARM MACHINERY LTD.

## Ireland's largest John Deere dealer Templetouhy Farm Machinery (TFM) selected Dotser Agri's e-commerce platform for an integration solution with John Deere's Machine Finder.

TFM engaged Dotser seeking a new look online interface with more control over product information, enhanced visibility, improved functionality (including greater eCommerce functionalities) and greater usability (UX) for the user.

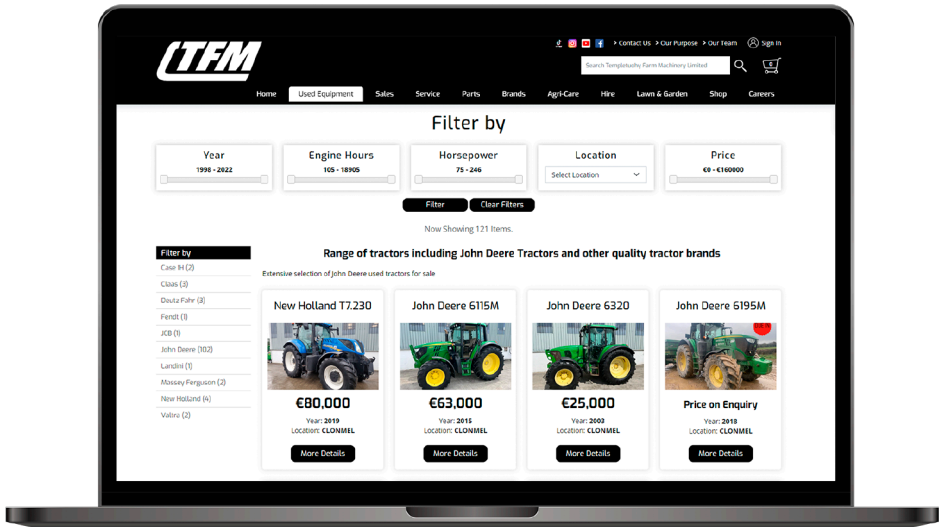

The new integration solution with the John Deere MachineFinder platform which saves the TFM sales team significant time when publishing machine stock listings online while also giving them enhanced control over how product images and information are displayed. Being able to highlight the relevant TFM sales person responsible for each machine type or product saves a lot of time by allowing customers get straight to the right person.

Automating the publishing of MachineFinder machinery direct to the Templetuohy Farm Machinery website saves duplication of work saving valuable time, resources and attention. Having the machinery data and listings on the website improves natural search engine ranking on Google, delivering greater online visibility and more potential customers direct to the TFM site.

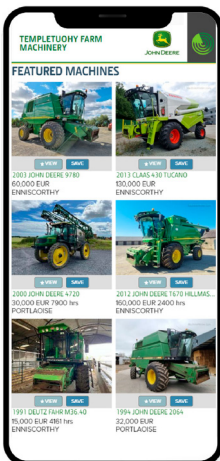

Integrated with



JOHN DEERE



# Dotser Agri

## About Us

### **Your Trusted Dynamic Ecommerce Solution Provider.**

Dotser are a cloud business solutions provider specialising in dynamic eCommerce solutions, waste management solutions WeRP, event management software (SuperShow), and web applications.

We pride ourselves on being **thorough, collaborative**, and holding utmost **integrity** for both ourselves and our clients. What this means is we work as a **partner**, to create and provide the **safest and most secure solutions**, with everyone's expectations met from start to finish. We are also focused; ensuring each client's project is **delivered on time, in full and to specification**.

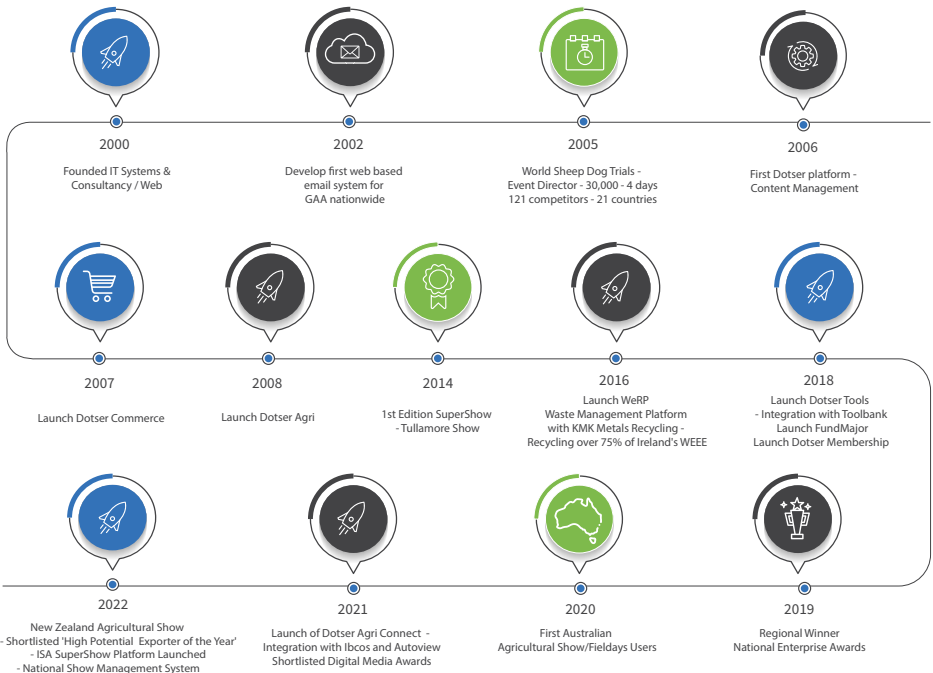

## Meet Your Team

When you work with us, your project is assigned to a team of key dedicated developers based on your requirements. In addition, the following key members will work with you throughout the process.



■ **Loughnan Hooper**  
CEO & Founder



■ **Geoff Liffey**  
Project Manager



■ **Alison Kenny**  
Accounts



■ **Nerijus Barauskas**  
Head of Development



■ **Ciara Kinnarney**  
SuperShow Manager



■ **Liam McKnight**  
Designer



■ **Andrés Macías**  
Senior Developer



■ **Karl O'Donnell**  
Front End Developer



# Dotser Agri

Machinery & Parts Dealer Platform

## Headquarters:

📍 25J Junction Office Suites, Axis Business Park,  
Clara Road, Tullamore, Offaly, R35 K6C5

📞 057 9323262

✉ sales@dotser.ie

---

**www.dotser.com**



dotser